

Glass Passivated Super Fast Rectifiers
Reverse Voltage 50 to 600 Volts, Forward Current 30 Amperes

Features

- Plastic package has underwriters laboratory flammability classifications 94V-0 flame retardant epoxy molding compound
- Glass passivated chip junctions
- Superfast recovery time, high voltage
- Low power loss, high efficiency
- High current capability, low forward voltage drop
- High surge capability
- Lead free in comply with EU RoHS 2011/65/EU directives

Mecanical Data

- Case : TO-247AD/TO-3P molded plastic
- Termals : Solder plated, lead free. solderable per MIL-STD-750, Method 2026
- Polarity:As marked
- Weight : 6.37 grams

Marking

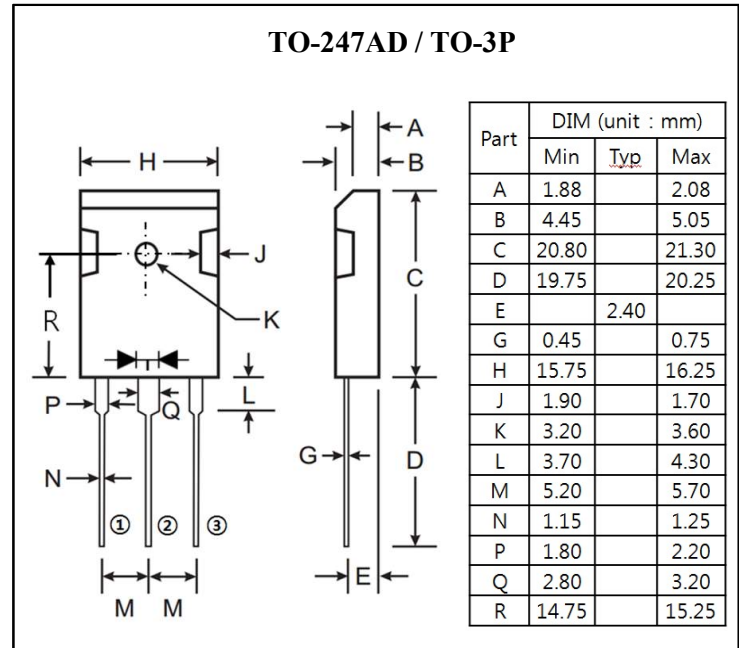
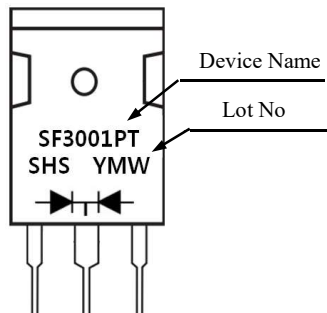

Equivalent Circuit

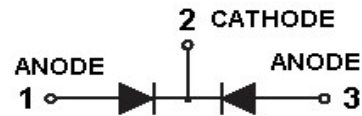

Maximum Ratings & Electrical Characteristics

Ratings at 25°C ambient temperature unless otherwise specified. Single phase, half wave, 60Hz, resistive or inductive load. For capacitive load, derate current by 20%

Parameter	Symbol	SF 3001 PT	SF 3002 PT	SF 3003 PT	SF 3004 PT	SF 3005 PT	SF 3006 PT	SF 3008 PT	Unit	Remark
Maximum Repetitive Peak Reverse Voltage	V_{RRM}	50	100	150	200	300	400	600	V	
Maximum RMS Voltage	V_{RMS}	35	70	105	140	210	280	420	V	
Maximum DC Blocking Voltage	V_{DC}	50	100	150	200	300	400	600	V	
Maximum Average Forward Rectified Current	$I_F(AV)$	30							A	
Peak Forward Surge Current 8.3ms Single Half Sine-wave Superimposed on Rated Load	I_{FSM}	300							A	
Maximum Instantaneous Forward Voltage at 15A	V_F	0.95			1.30		1.70		V	
Maximum DC Reverse Current at Rated DC Blocking Voltage	I_R	10							uA	Ta=25°C
		500							uA	Ta=125°C
Maximum Reverse Recovery Time	t_{rr}	35							ns	Note 2
Typical Junction Capacitance	C_J	175							pF	Note 3
Typical Thermal Resistance	$R_{th(j-c)}$	1.0							°C/W	
Operation Junction Temperature Range	T_J	-55 to +150							°C	
Storage Temperature Range	T_{STG}	-55 to +150							°C	

Note 1 : Pulse Test with PW=300us, 1% Duty Cycle

Note 2 : Reverse Recovery Test Conditions : IF=0.5A, IR=1.0A, Recover to 0.25A

Note 3 : Measured at 1 MHz and Applied Reverse Voltage of 4.0V D.C.



Ratings and Characteristics Curves ($T_a=25^\circ\text{C}$ unless

Fig.1 Forward Current Derating Curve

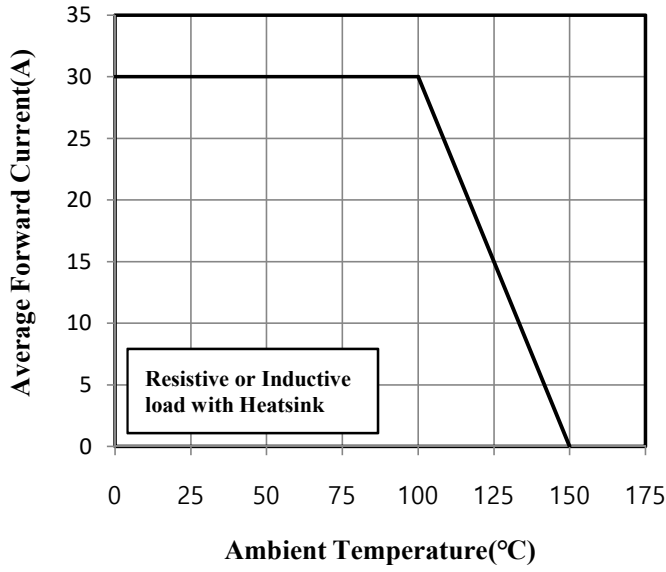

Fig.2 Maximum Non-Repetitive Peak Forward Surge Current

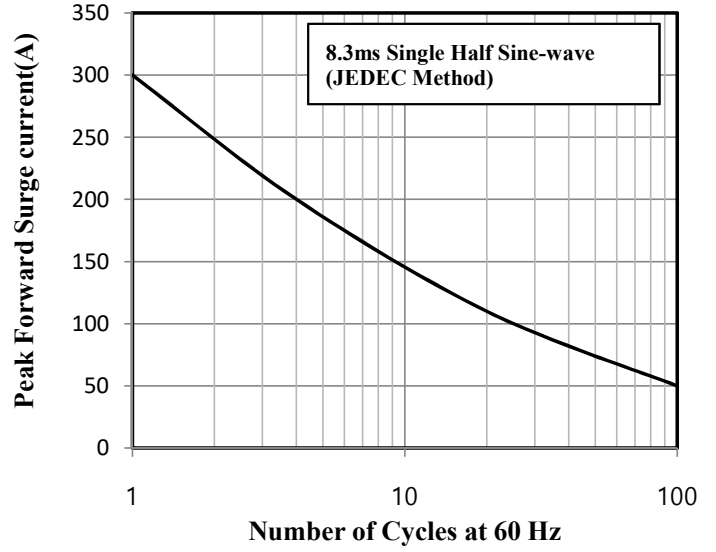

Fig.3 Typical Instantaneous Forward Characteristics

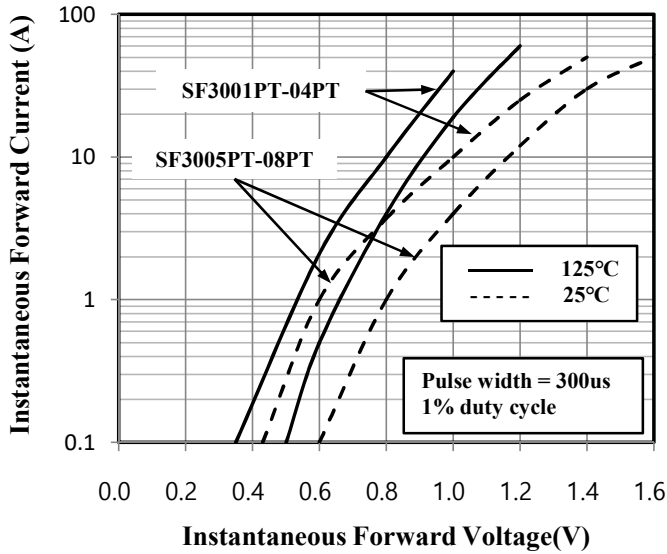

Fig.4 Typical Junction Capacitance

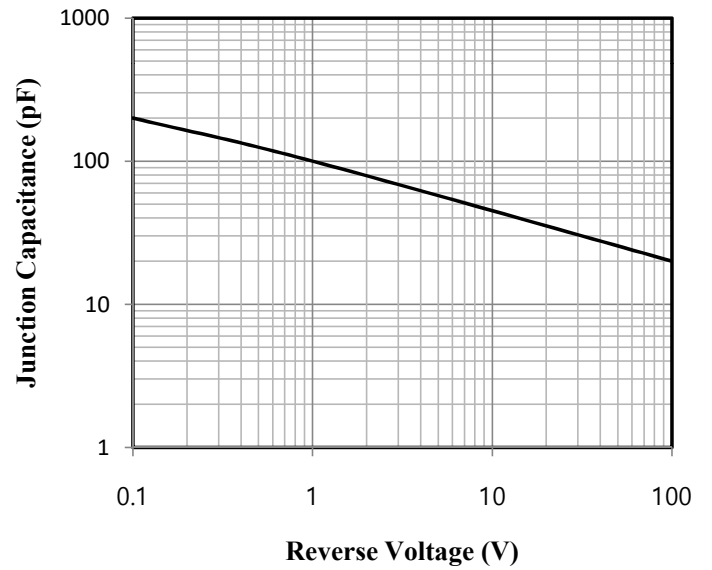

Fig.5 Typical Reverse Characteristics

